

Operating & Maintenance Instructions

600/1000/1500/2000

SF Range

DF Range

WF Range

Table of Contents

1. Introduction	3
2. Health & Safety Information	4
3. Machine Parts	4
4. Unpacking & Location	5
5. Electrical Supply & Connection.....	6
6. Base Frame & Stand.....	7
7. Power Pack Controls	9
8. Heater Beams	12
9. Operating the Machine.....	16
10. General Setting Guidance.....	19
11. Maintenance	20

1. Introduction

This range of Strip Heaters is designed for the local heating of thermoplastic materials. The machine uses tensioned resistance wires for even and accurate heating of the material to be formed. Up to four heater beams can be fitted to the machine to enable more complex components to be fabricated in one operation. All heater beams are controlled by power packs fitted with low voltage transformers and circuit protection.

A range of accessories is available for this range of equipment, including stands with castors, additional heating beams and power packs, and folding jigs.

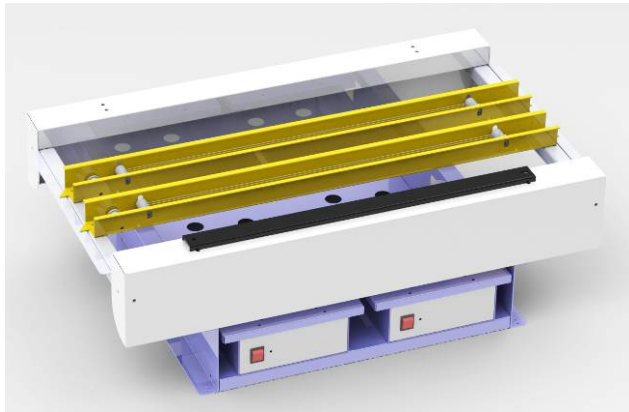

SF Range

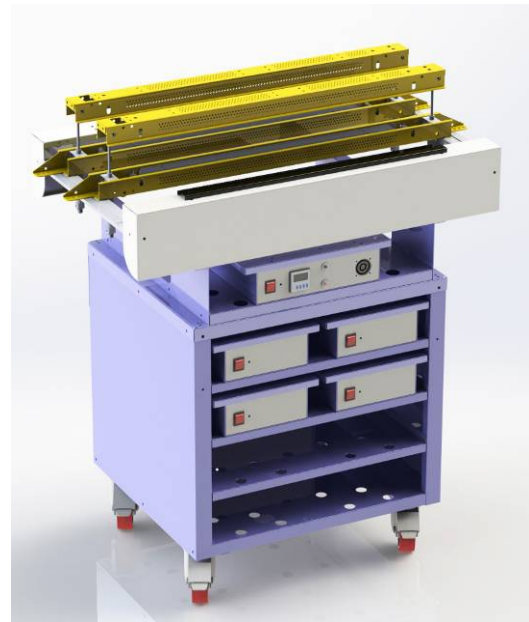

DF Range



WF Range

2. Health & Safety Information

The surfaces of the heater beams will get hot when in use. Heat-proof gloves should be worn when operating the machine.

This range of equipment is specifically designed for the fabrication of thermoplastic materials. Should the user be unsure of the origin or suitability of any material for use on this machine, they should refer to the material MSDS or material supplier before attempting to use it on the machine.

3. Machine Parts

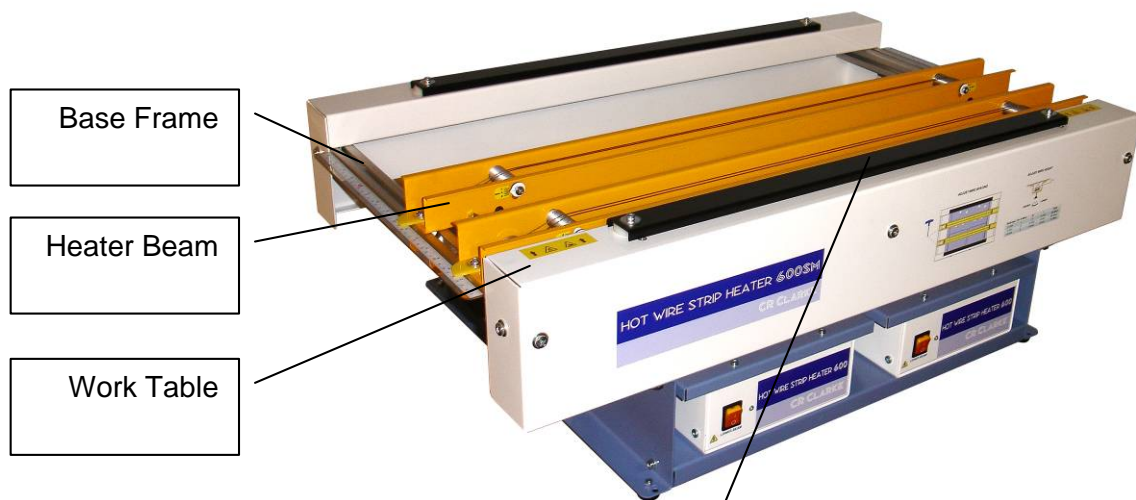

Workstop. Note that there are two sets of mounting holes for the workstop. The operator can choose which set are most appropriate depending upon the characteristics of the panel being produced.

4. Unpacking & Location

Your new machine will reach you flat-packed and will require some assembly. Please refer to the assembly instructions provided with the machine for this.

Position the machine on a work surface or position the stand (if used) as required.

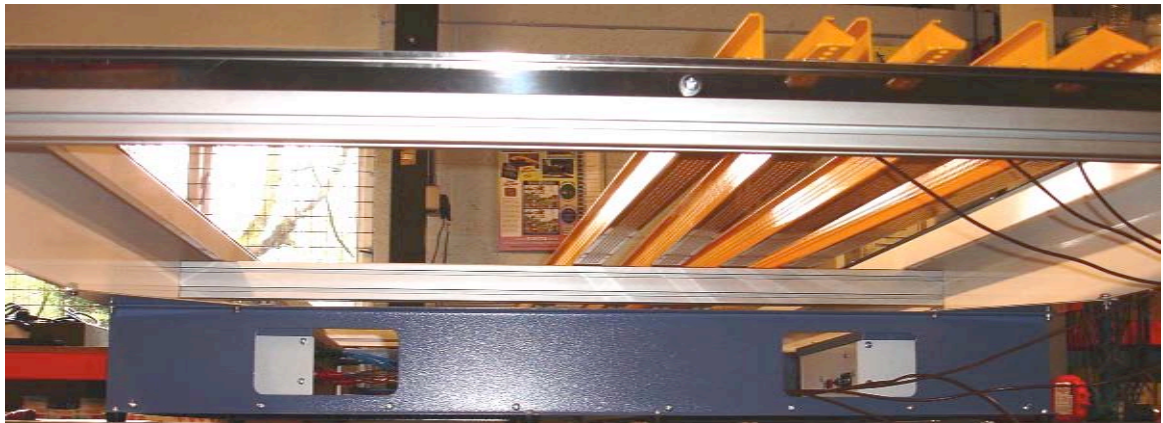
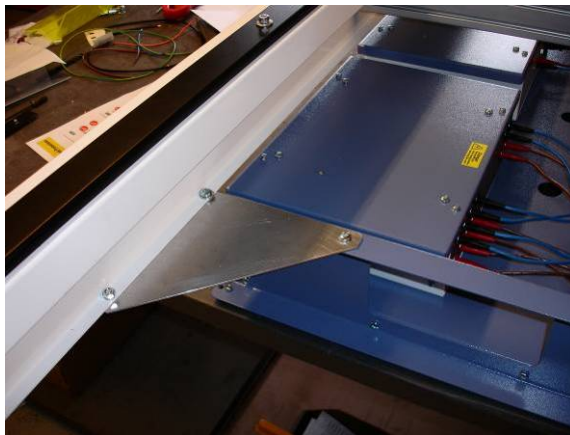
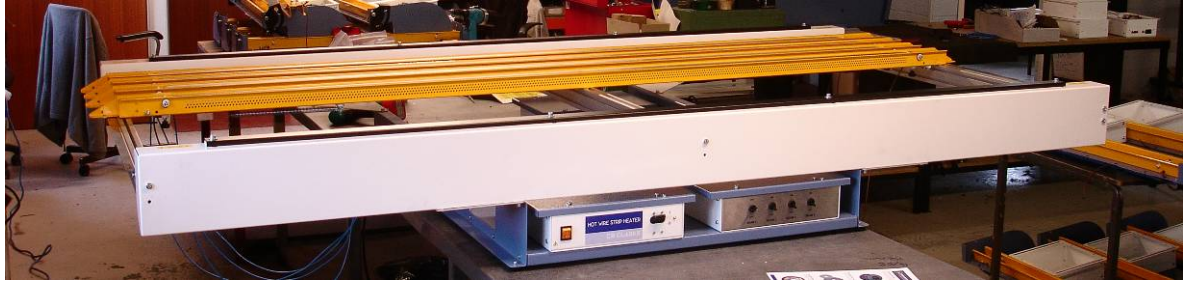

5. Electrical Supply & Connection

Your new machine requires a 220-240V electrical supply, at 50-60Hz. Current ratings are as follows:

600P	Hot Wire Control Power Pack	1.0A
1000P	Hot Wire Control Power Pack	2.0A
1500P	Hot Wire Control Power Pack	3.0A
2000P	Hot Wire Control Power Pack	3.5A
600PC	Contact Heating Control Unit	6.0A
1000PW	Wide Band Heating Control Unit	8.0A
1500PW	Wide Band Heating Control Unit	10A
2000PW	Wide Band Heating Control Unit	13A
600PT	Timer Control Unit	0.5A

Should more than one Power Pack be used in a machine, add up the current consumption of each power pack to ensure that the incoming power supply is adequate.

For machines supplied with stands, a suitable distribution box will be supplied for the electrical power. This is mounted onto the rear panel of the stand.

Electrical supply to the machine must be in accordance with the details shown on the rating label. As the colours of the wires in this mains lead may not correspond with the coloured markings identified in your plug appliance, should the plug need to be changed proceed as follows: -

The wire that is coloured green and yellow must be connected to the terminal that is marked with the letter E or by the earth symbol or coloured green and yellow or green.

The wire that is coloured blue must be connected to the terminal that is marked with the letter N or coloured blue or black.

The wire that is coloured brown must be connected to the terminal that is marked with the letter L or coloured brown or red.

Should there be any queries regarding the electrical requirements of your machine please refer back to the manufacturer or their nominated distributor.

6. Base Frame & Stand

This range of strip heaters is designed around a standard base frame. A stand is available as an optional extra for single sided machines. It is normally included with double sided, wide band and contact heaters, to accommodate the power packs. The Base frame is available in two depths, standard (MF) with maximum beam centres of 350mm, and extended (MFE) with maximum beam centres of 1000mm. Please note that the extended base frame must be used with the sliding table and wide band heater beams.



Slide rails on the sides of the base frame allow the securing of heater beams, and calibrations are fitted to aid quick setup. The sliding nuts for each heater beam can be fitted by placing them on edge into the groove, and then rotating them into position using a small screwdriver or similar. To adjust the position of a heater beam, slacken the securing screw by around 1 turn using a 5mm hexagon key. Move the beam as required, and then re-secure. Wire beams have pointers incorporated for ease of positioning.

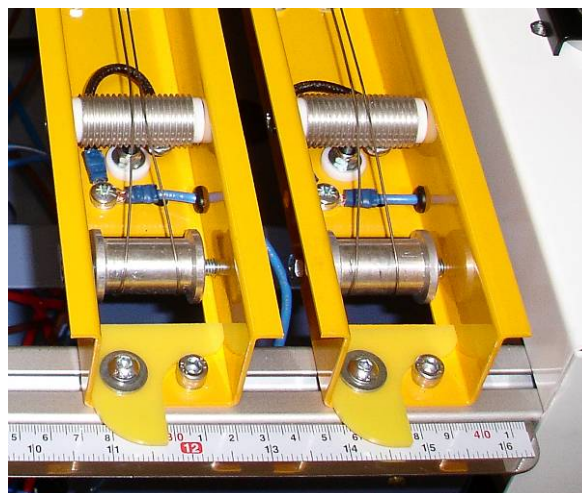

The workstop on the front table of the machine provides a fixed reference point for the edge of the material being formed. It can be fitted in either one of two positions, or at the rear of the machine, depending upon operator preference.

The baseplate of the base frame has a shelf to hold power packs, and generous openings are left so that power and control cables can be fed to the heater beams.

Different types of heater beams can be mixed and matched on a single base frame, for example to allow a tight fold and a radius bend to be produced in a single heating operation.

Upper Frame to Support Wide Band Heating Beams

Where Wide Band Heating Beams are used above the material, upper slide bars are attached to the base frame to support these. The upper slide rails can be adjusted vertically using the selection of holes.



Attaching Wide Band Heating Beams beneath the work piece

Wide band heating beams can be also be fitted beneath the workpiece, enabling double sided heating. When this is done, they are fitted to the underside of the beam slide rails. Note that, when underside wide band heating beams are being used, it is preferable to use separately available support slats, as opposed to the sliding table.

Sliding Table for use with Wide Band Heating Beams

This allows an entire sheet of material to be placed under the overhead Wide Band Heating Beams. The sliding table rolls on the beam slide rails. Please note that the sliding table can only be fitted to the extended base frame (MFE), and also that any hot wire heater beams have to be removed to allow it to slide correctly.

7. Power Pack Controls

Power Packs are available to suit all of the types of heater supplied with this range. Their functions and operation are detailed in the sections below.

7a. *00P Hot Wire Control Unit

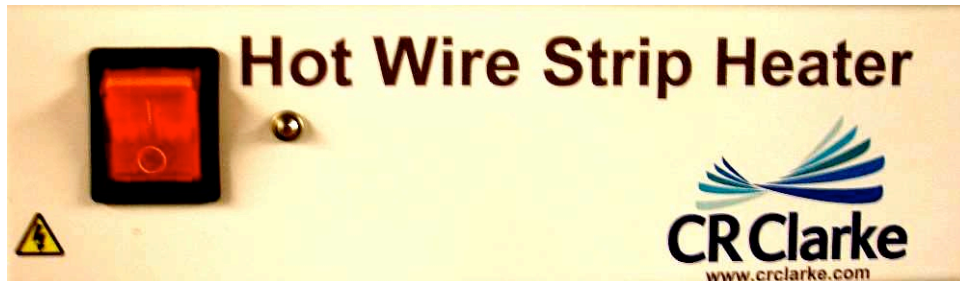

I: On O: Off

Front Panel View

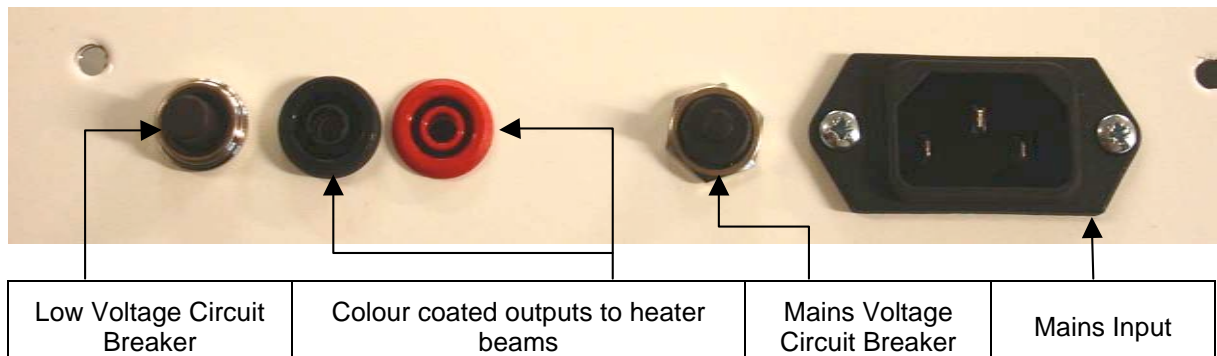

Rear Panel View

7b. *00PW Wide Band Heating Control Unit

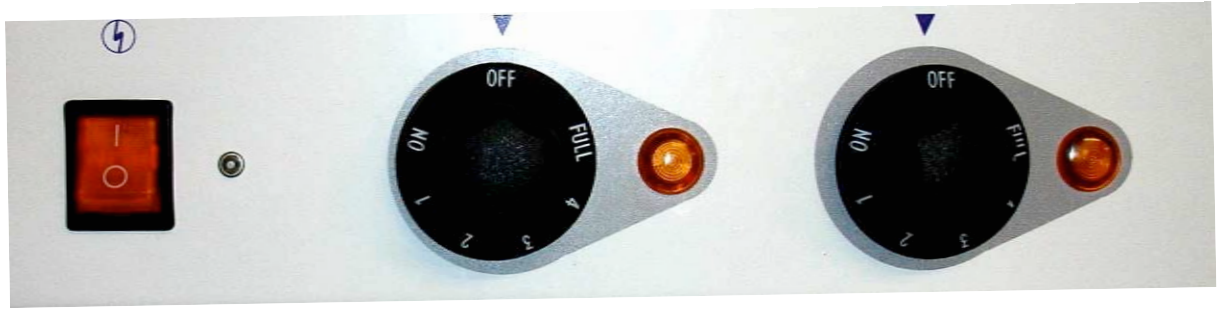

I: On O: Off	Energy Regulator 1 Note that when not on full power, the indicators will pulse on and off	Energy Regulator 2
--------------	--	--------------------

Front Panel View



Outputs to wide band beams	Circuit Breakers	Mains Input
----------------------------	------------------	-------------

Rear Panel View

7c. *00PC Contact Heating Control Unit



I: On O: Off	Temperature Controllers: display set and current temperatures
--------------	---

Front Panel View



Outputs to contact heating beams	Circuit Breakers	Mains Input
----------------------------------	------------------	-------------

Rear Panel View

7d. *00PT Timer Control Unit

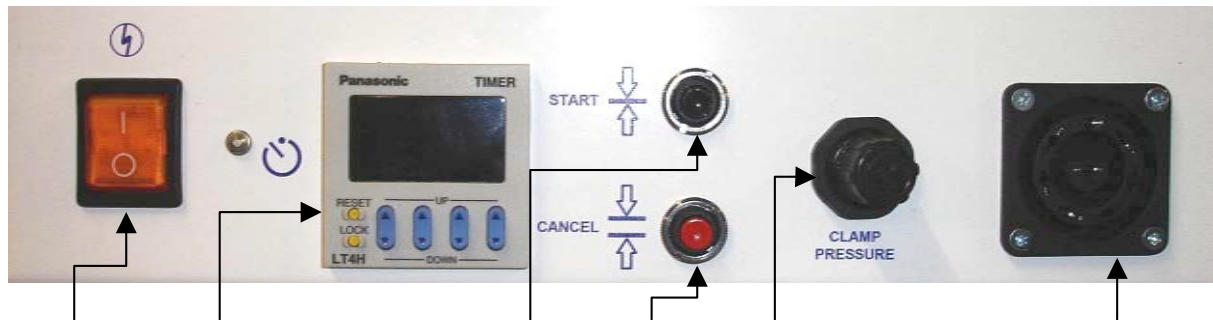

<p>I: On O: Off</p>	<p>Timer: Use the <i>Up</i> and <i>Down</i> buttons to set the time.</p> <p>Press the <i>Lock</i> button to prevent time being adjusted (Lock will show on display).</p> <p>Press <i>Lock</i> again to release adjustment lock</p>	<p>Cycle Start</p>	<p>Cycle Cancel</p>	<p>Clamp Pressure:</p> <p>Turn clockwise to reduce clamp pressure.</p> <p>Turn anti-clockwise to increase clamp pressure.</p>	<p>Footswitch socket</p>
-------------------------	--	--------------------	---------------------	---	--------------------------

Front Panel View



<p>Compressed Air: Outputs to heater beams. Any unused outputs must be plugged and looped together.</p>	<p>Compressed Air in -5-8 bar</p>	<p>Circuit Breaker</p>	<p>Mains Input</p>
---	-----------------------------------	------------------------	--------------------

Rear Panel View

8. Heater Beams

Heater Beams are available in a range of options for maximum flexibility. All heater beams attach to the base frame using M6 socket head screws, which can be adjusted using a 5mm hexagon key.

8a Hot Wire Heater Beams – Single Sided

These heater beams have heating wires on the underside only. One or two heating wires can be used depending upon the thickness of the material being processed. For information on setting wire heights, spacings etc, refer to Section 7.3 below.

8b Hot Wire Heater Beams – Double Sided

These heater beams have heating wires on both the underside and upper beam. Pneumatic cylinders operate the upper beam in conjunction with the 600PT Timer Control Unit. The speed of operation of the upper beam is controlled via the flow regulators mounted on each cylinder. The upper flow regulators control the upward speed of the beam, with the lower flow regulators controlling the downward speed. Turning the regulators clockwise reduces the speed of movement, turning them anti-clockwise increases the speed. For information on setting wire heights, spacings etc, refer to Section 7.3 below.

8c Heating Wire Adjustment

The heater beams incorporate grooved wire guides for wire position and height adjustment, and the ability to remove heating wires when not required. **IMPORTANT.** Always switch the machine off at the Power Pack before adding or removing wires, or moving wires in the grooved wire guides. Wire height can be adjusted with the wires switched on.

To add a wire:

Make up a heating wire from 20SWG 80/20 Nickel Chrome wire (C R Clarke part numbers WX02 or 900/32). The length of each wire should be as follows:

600	1005mm
1000	1420mm
1500	1905mm
2000	2305mm

The wires should have a loop formed in each end, with the tail of the loop twisted around the body of the wire (see diagram below).



Fit the heating wire around the fixed post on the end of the heater beam.

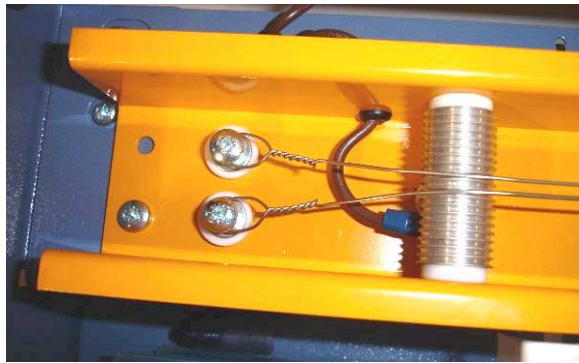

While holding the wire under slight tension, lay it across the grooved rollers and feed the end of it around the guide roller at the other end of the heater beam.



Attach the tensioning spring.

Pull the tensioning spring and hook it onto its securing post.

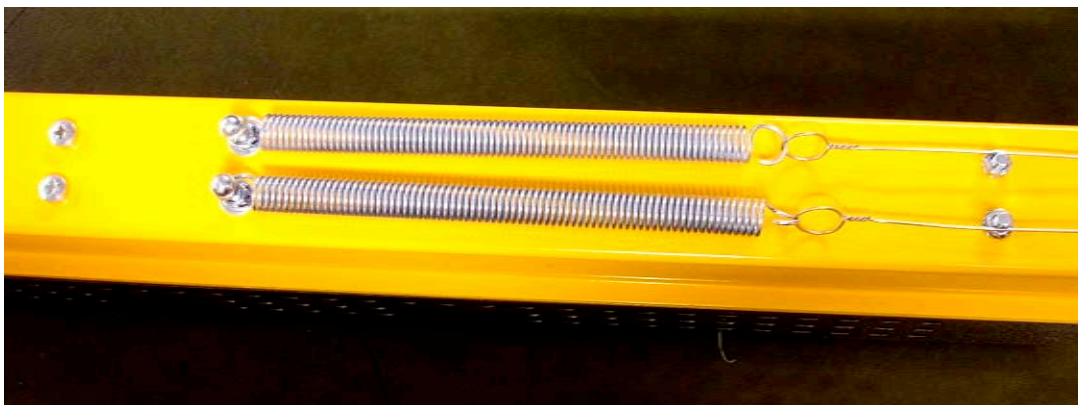

Please note that each heater beam will accommodate a maximum of two heating wires.

To remove a wire:



Unhook the tensioning spring from its securing post.

Release the tension in the spring and unhook it from the heating wire.

Remove the heating wire.

Adjusting the wire height



Use the adjusting knobs underneath each end of the heater beam. Looking from beneath, turning clockwise lowers the heating wires. Turning anti-clockwise raises the heating wires.

There is a pointer on the side of each grooved wire guide, to assist setting.

Adjusting the Wire Positions

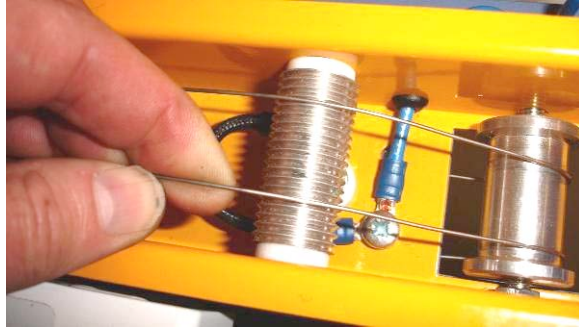

Ensure that the wires have cooled fully before handling. Lift the wire out of its groove, and position in the required groove





Wide Band Heaters

The Wide Band Heating Beams are fitted with adjustable side reflectors to control the heat band. These can be adjusted at either end using a 5mm hexagon key. To produce a heat band wider than one beam, heater beams can be slid up against each other. Intermediate reflectors can either be opened out all the way or removed when used in this way.







9. Operating the Machine

9a. Single Sided Wire Beams

	<p>Set up the heating wires and beam positions as required.</p>
	<p>Switch the power pack(s) on and allow the heating wires to warm up.</p>
	<p>Load the material to be folded and allow to warm up.</p>
	<p>Remove the material from the machine, and allow to cool.</p>

9b. Double Sided Wire Beams

	<p>Set up the heating wires and beam positions as required.</p>
	<p>Switch the power pack(s) on and allow the heating wires to warm up.</p>
	<p>Set the Timer to the required cycle time.</p>
	<p>Load the material and press the start button or the foot pedal. Allow the material to warm up.</p>
	<p>Remove the material from the machine, and allow to cool.</p>

9c. Operating the Machine – Wide Band Heater Beams

	<p>Set up the heating beam positions as required. Set the reflector positions as required.</p>
	<p>Switch the power pack(s) on, set the Energy Regulators to full and allow the heating beams to warm up.</p>
	<p>Load the material and slide under the heaters. Allow the material to heat and soften.</p>
	<p>Remove the material from the machine, form as required and allow to cool.</p>

10. General Setting Guidance

Thin Materials (<1.5mm)

Use a single heating wire to obtain a tight, well-defined heat band. If using double sided heating use a single wire top and bottom. Keep wires close to the material (2-3mm), again to reduce heat band width.

Medium Materials (2 – 4mm)

Use two wires close together. If using double sided heating, use a single wire on the top. Always try to bend the material upwards, so that the wider heat band is on the outside of the finished piece. Heating wires are still close to the material (2-3mm).

Thicker Materials (5-8mm)

Use two wires, and two above if double sided heating is available. Start to spread the wires further apart (5mm on bottom, 3mm on top if available). Move the wires further from the material (3-5mm) to allow the heat to diffuse through the material more gently.

Thick Materials (8mm+)

This is only possible using double sided heating. Use wires spread well apart (8mm bottom, 6mm top), and quite far away from the material (5-6mm). If creasing appears on the inside of the fold, the upper face is getting too hot. In this instance reduce the upper heat band by moving the top wires away from the material and the bottom wires closer to the material.

11. Maintenance

Hot Wire Heater Beams

Ensure that the grooved wire guides are kept clean. If required, remove the heating wires periodically and gently clean using a suede brush or similar.

Should wires break or become tarnished and inefficient, they must be replaced as described in the appropriate section.

Wide Band Heater Beams

Ensure that no heating elements are broken or damaged. If any heating element is damaged, the machine must not be used.

All machines

A PAT Test should be carried out annually.

For all spare parts and technical support, please contact your supplier or alternatively refer to the machine manufacturer:

C R Clarke & Co (UK) Limited
Unit 3 Betws Industrial Park
Foundry Road
Ammanford
Carms
SA18 2LS
UK

Tel : 0 (+044) 1269 590530
Fax : 0 (+044) 1269 590540
Email : info@crclarke.co.uk

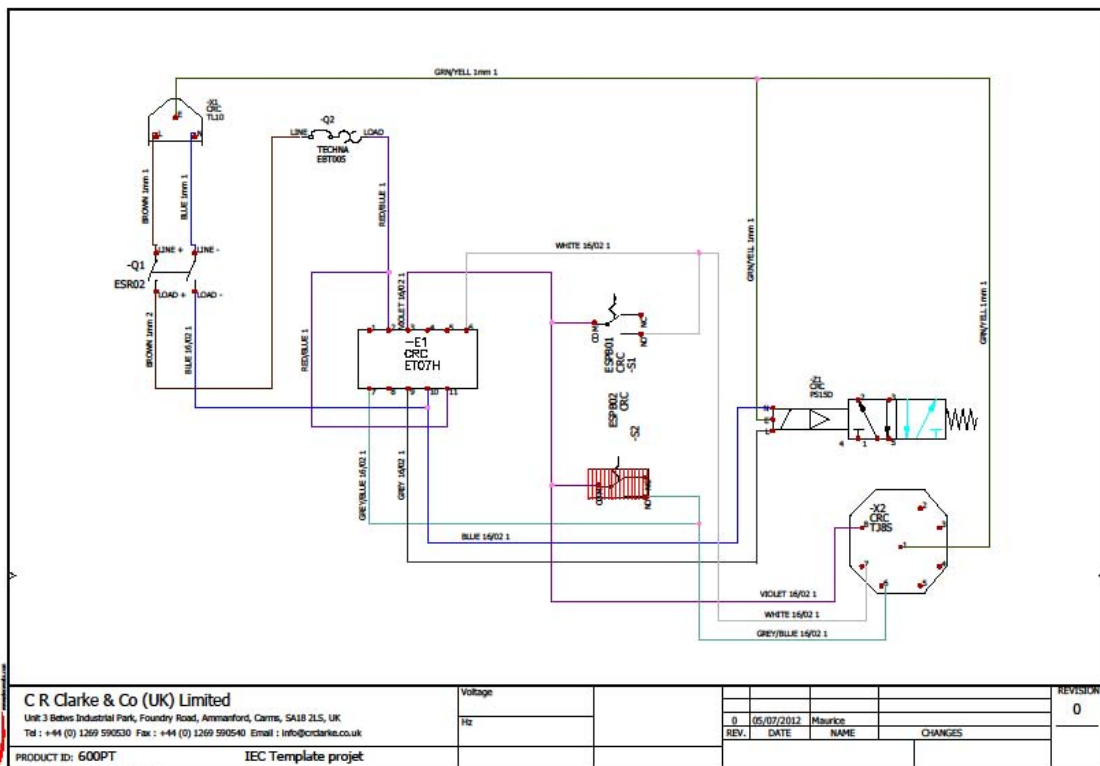
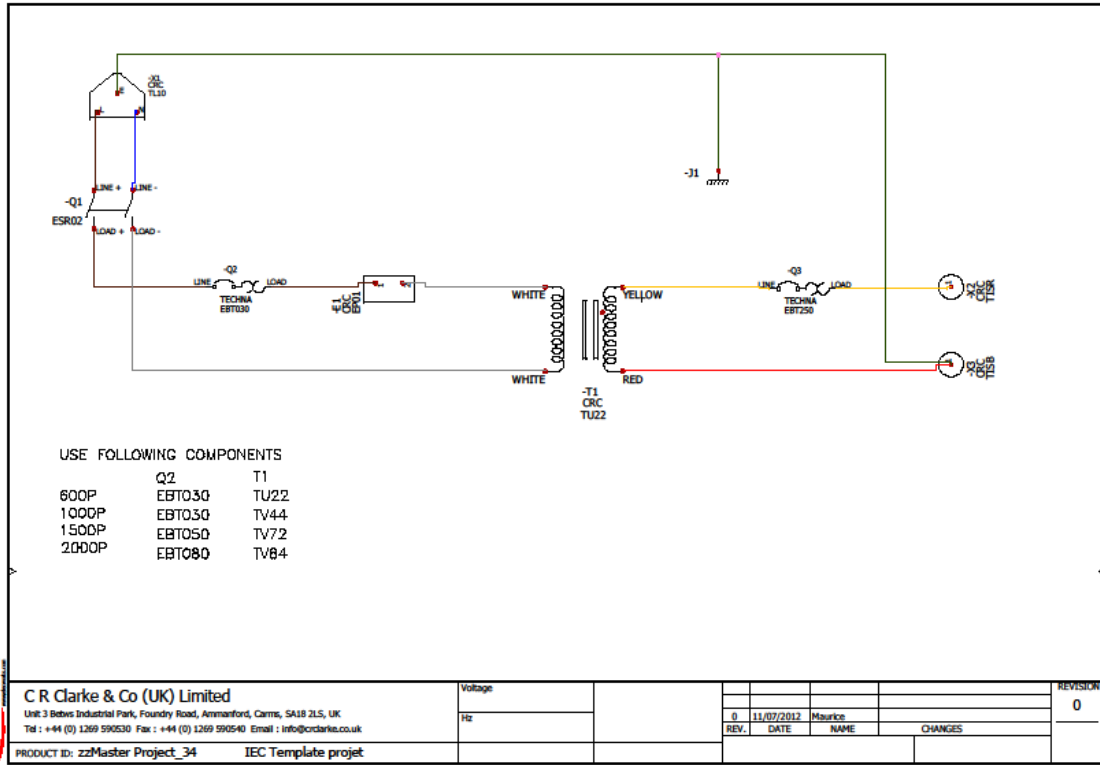

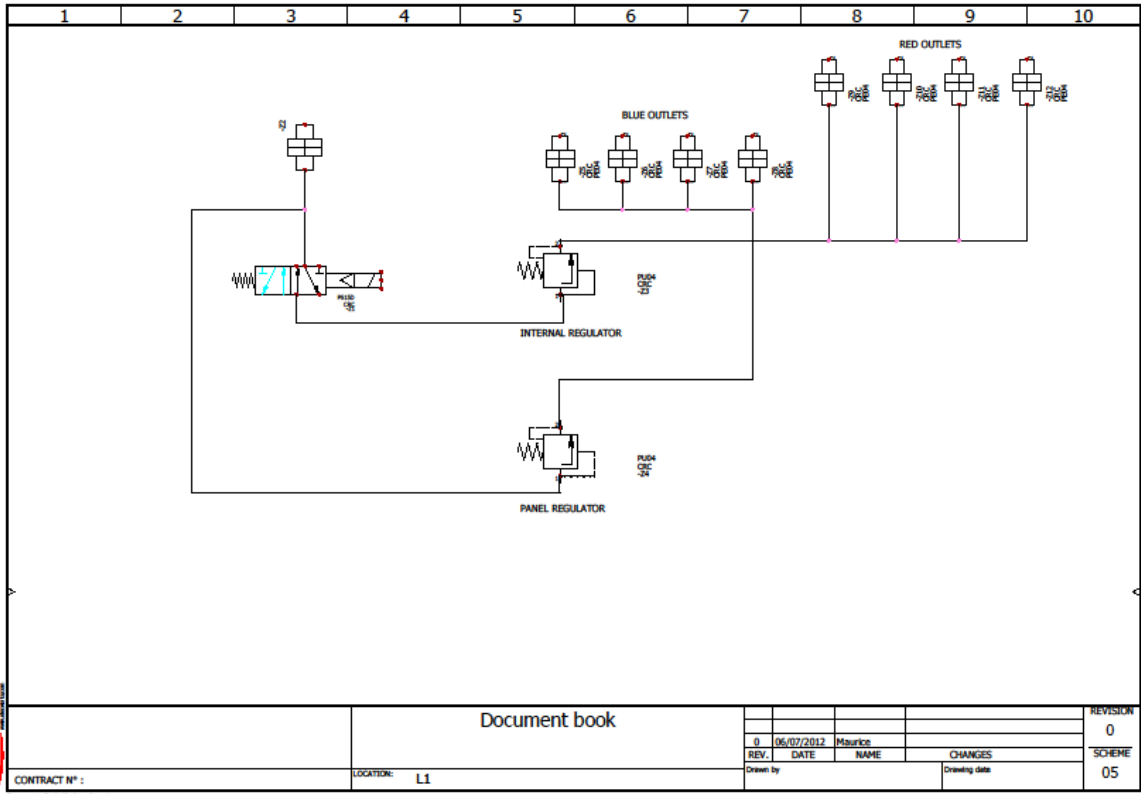

Trace Software

Document book

CONTRACT N° :		LOCATION: L1	REVISION	
				0
REV.	DATE	NAME	CHANGES	SCHEME
				05